

Approval body for construction products
and types of construction

Bautechnisches Prüfamt

An institution established by the Federal and
Laender Governments



European Technical Assessment

ETA-15/0247
of 7 May 2015

English translation prepared by DIBt - Original version in German language

General Part

Technical Assessment Body issuing the
European Technical Assessment:

Deutsches Institut für Bautechnik

Trade name of the construction product

Injection system TCM385RE, TCM585RE, TCM1000RE,
TCM1400RE for rebar connection

Product family
to which the construction product belongs

Post-installed rebar connection with
Injection System TCM385RE, TCM585RE,
TCM1000RE, TCM1400RE

Manufacturer

TRUTEK Fasteners Polska Sp z o.o
Al. Krakowska 55, Sekocin Nowy
05-090 RASZYN
POLEN

Manufacturing plant

FACTORY PLANT 1

This European Technical Assessment
contains

15 pages including 3 annexes which form an integral part
of this assessment

This European Technical Assessment is
issued in accordance with Regulation (EU)
No 305/2011, on the basis of

Guideline for European technical approval of "Metal
anchors for use in concrete", ETAG 001 Part 5: "Bonded
anchors", April 2013,
used as European Assessment Document (EAD)
according to Article 66 Paragraph 3 of Regulation (EU)
No 305/2011.

The European Technical Assessment is issued by the Technical Assessment Body in its official language. Translations of this European Technical Assessment in other languages shall fully correspond to the original issued document and shall be identified as such.

Communication of this European Technical Assessment, including transmission by electronic means, shall be in full. However, partial reproduction may only be made with the written consent of the issuing Technical Assessment Body. Any partial reproduction has to be identified as such.

This European Technical Assessment may be withdrawn by the issuing Technical Assessment Body, in particular pursuant to information by the Commission according to Article 25 Paragraph 3 of Regulation (EU) No 305/2011.

Specific Part

1 Technical description of the product

The subject of this approval is the post-installed connection, by anchoring or overlap connection joint, of reinforcing bars (rebars) in existing structures made of normal weight concrete, using the "Injection system TCM385RE, TCM585RE, TCM1000RE, TCM1400RE for rebar connection" in accordance with the regulations for reinforced concrete construction.

Reinforcing bars made of steel with a diameter ϕ from 8 to 25 mm according to Annex A 2 and injection mortar TCM385RE, TCM585RE, TCM1000RE, TCM1400RE are used for rebar connections. The rebar is placed into a drilled hole filled with injection mortar and is anchored via the bond between rebar, injection mortar and concrete.

An illustration and the description of the product are given in Annex A.

2 Specification of the intended use in accordance with the applicable European assessment Document

The performances given in Section 3 are only valid if the anchor is used in compliance with the specifications and conditions given in Annex B.

The verifications and assessment methods on which this European Technical Assessment is based lead the assumption of working life of the anchor of 50 years. The indications given on the working life cannot be interpreted as a guarantee given by the producer, but are to be regarded only as a means for choosing the right products in relation to the expected economically reasonable working life of the works.

3 Performance of the product and references to the methods used for its assessment

3.1 Mechanical resistance and stability (BWR 1)

Essential characteristic	Performance
Design values of the ultimate bond resistance	See Annex C 1

3.2 Safety in case of fire (BWR 2)

Essential characteristic	Performance
Reaction to fire	Anchorage satisfy requirements for Class A1
Resistance to fire	No performance determined (NPD)

3.3 Hygiene, health and the environment (BWR 3)

Not applicable.

3.4 Safety in use (BWR 4)

The essential characteristics regarding Safety in use are included under the Basic Works Requirement Mechanical resistance and stability.

3.5 Protection against noise (BWR 5)

Not applicable.

3.6 Energy economy and heat retention (BWR 6)

Not applicable.

English translation prepared by DIBt

3.7 Sustainable use of natural resources (BWR 7)

The sustainable use of natural resources was not investigated.

3.8 General aspects

The verification of durability is part of testing the essential characteristics. Durability is only ensured if the specifications of intended use according to Annex B are taken into account.

4 Assessment and verification of constancy of performance (AVCP) system applied, with reference to its legal base

According to Decision of the Commission of 24 June 1996 (96/582/EC) (OJ L 254 of 08.10.96 p. 62-65), the system of assessment and verification of constancy of performance (see Annex V and Article 65 Paragraph 2 to Regulation (EU) No 305/2011) given in the following table applies.

Product	Intended use(s)	Level or class	System
Metal anchors for use in concrete (heavy-duty type)	For fixing and/or supporting concrete structural elements or heavy units such as cladding and suspended ceilings	—	1

5 Technical details necessary for the implementation of the AVCP system, as provided for in the applicable European assessment Document

Technical details necessary for the implementation of the AVCP system are laid down in the control plan deposited at Deutsches Institut für Bautechnik.

Issued in Berlin on 7 May 2015 Deutsches Institut für Bautechnik

Uwe Bender
Head of Department

beglaubigt:
Baderschneider

Figure A1: Overlapping joint for rebar connections of slabs and beams

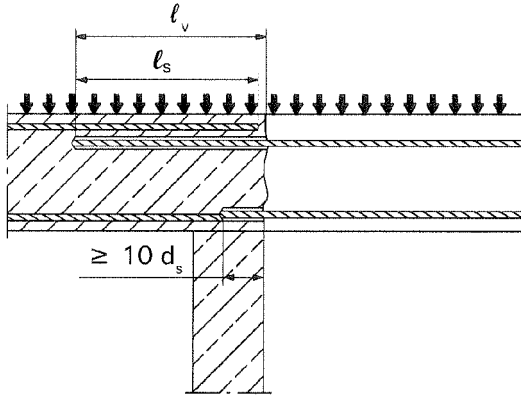

Figure A3: End anchoring of slabs or beams, designed as simply supported

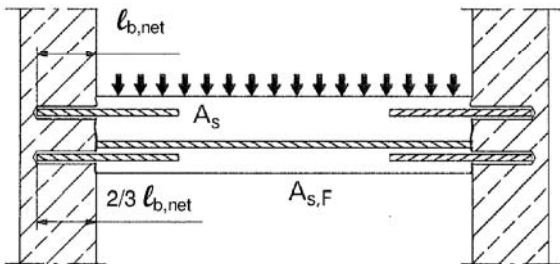

Figure A2: Overlapping joint at a foundation of a wall or column where the rebars are stressed in tension

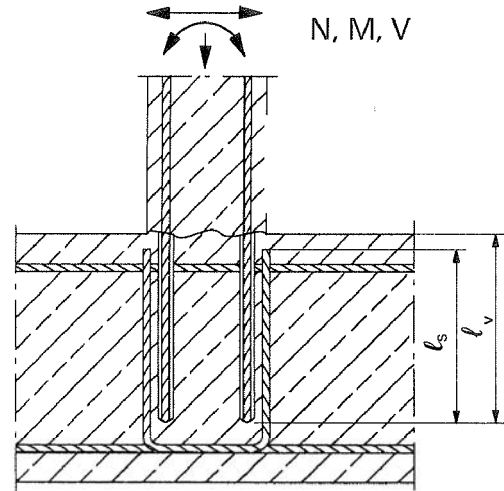

Figure A4: Rebar connection for components stressed primarily in compression. The rebars are stressed in compression

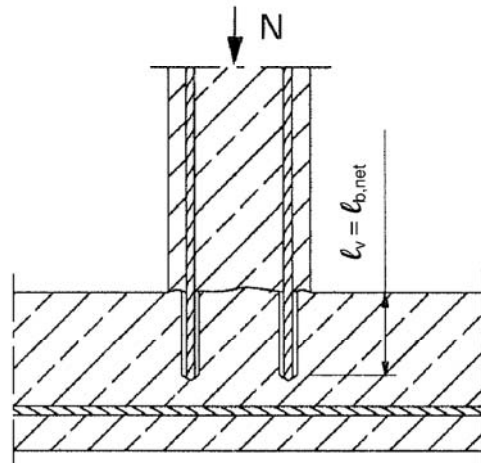
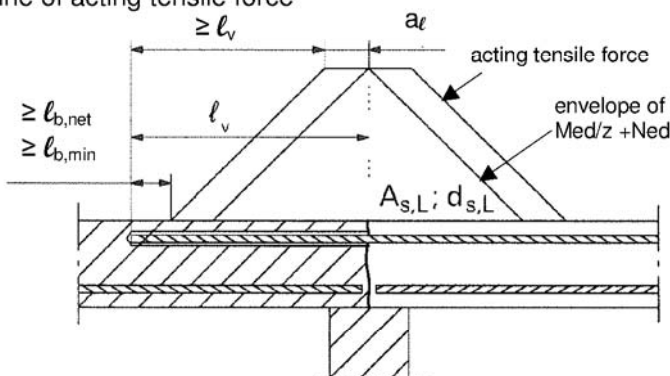

Figure A5: Anchoring of reinforcement to cover the line of acting tensile force



Note to Figure A1 to A5:

In the Figures no transverse reinforcement is plotted, the transverse reinforcement shall comply with EN 1992-1-1:2004+AC:2010.

Preparing of joints according to Annex B 2

Injection system TCM385/585/1000/1400RE for rebar connection

Product description

Installed condition and examples of use for rebars

Annex A 1

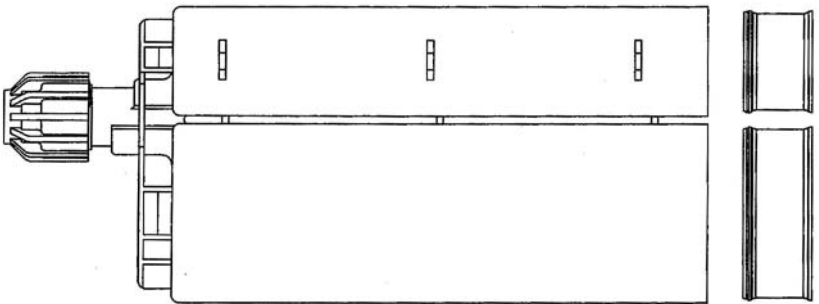
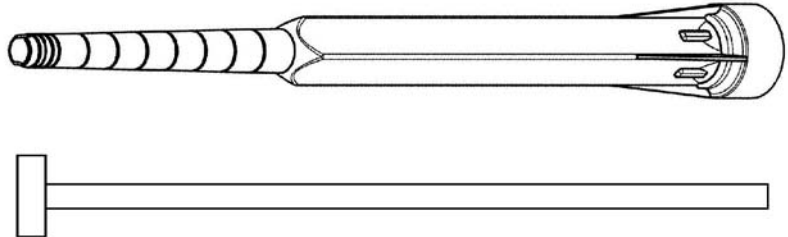
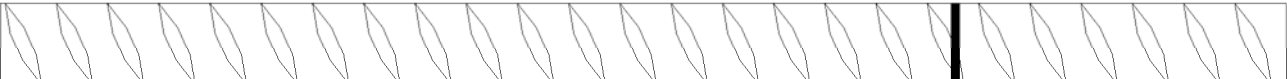
Product description and intended use					
<p>Injection mortar: TCM385/585/100RE</p> <p>Typ "side-by-side": 385 ml, 585 ml, 1000 ml and 1400 ml</p>	 <p>Label: TCM385/585/100RE, processing notes, charge-code, shelf life, hazard-code, curing- and processing time (depending on the temperature), with as well as without travel scale</p>				
<p>Static Mixer</p> <p>Piston plug and mixer extension</p>					
Reinforcing bar (rebar): ø8, ø10, ø12, ø14, ø16, ø20, ø22, ø24, ø25					
					
<p>Minimum value of related rip area $f_{R,min}$ according to EN 1992-1-1:2004+AC:2010</p> <ul style="list-style-type: none"> Rib height of the bar shall be in the range $0,05d \leq h \leq 0,07d$ (d: Nominal diameter of the bar; h: Rip height of the bar) 					
Table A1: Materials					
<table border="1"> <thead> <tr> <th>Designation</th> <th>Material</th> </tr> </thead> <tbody> <tr> <td>Rebar EN 1992-1-1:2004+AC:2010, Annex C</td> <td>Bars and de-coiled rods class B or C f_{yk} and k according to NDP or NCL of EN 1992-1-1/NA:2013 $f_{tk} = f_{tk} = k \cdot f_{yk}$</td> </tr> </tbody> </table>		Designation	Material	Rebar EN 1992-1-1:2004+AC:2010, Annex C	Bars and de-coiled rods class B or C f_{yk} and k according to NDP or NCL of EN 1992-1-1/NA:2013 $f_{tk} = f_{tk} = k \cdot f_{yk}$
Designation	Material				
Rebar EN 1992-1-1:2004+AC:2010, Annex C	Bars and de-coiled rods class B or C f_{yk} and k according to NDP or NCL of EN 1992-1-1/NA:2013 $f_{tk} = f_{tk} = k \cdot f_{yk}$				
Injection system TCM385/585/1000/1400RE for rebar connection	Annex A 2				
Product description Injection mortar / Static mixer / Rebar Materials					

Specifications of intended use

Anchorage subject to:

- Static and quasi-static loads.

Base materials:

- Reinforced or unreinforced normal weight concrete according to EN 206-1:2000.
- Strength classes C12/15 to C50/60 according to EN 206-1:2000.
- Maximum chloride concrete of 0,40% (CL 0.40) related to the cement content according to EN 206-1:2000.
- Non-carbonated concrete.

Note: In case of a carbonated surface of the existing concrete structure the carbonated layer shall be removed in the area of the post-installed rebar connection with a diameter of $d_s + 60$ mm prior to the installation of the new rebar.

The depth of concrete to be removed shall correspond to at least the minimum concrete cover in accordance with EN 1992-1-1:2004+AC:2010.

The foregoing may be neglected if building components are new and not carbonated and if building components are in dry conditions.

Temperature Range:

- - 40°C to +80°C (max. short term temperature +80°C and max long term temperature +50°C).

Design:

- Anchorages are designed under the responsibility of an engineer experienced in anchorages and concrete work.
- Verifiable calculation notes and drawings are prepared taking account of the forces to be transmitted.
- Design according to EN 1992-1-1:2004+AC:2010 and Annex B 2.
- The actual position of the reinforcement in the existing structure shall be determined on the basis of the construction documentation and taken into account when designing.

Installation:

- Dry or wet concrete.
- It must not be installed in flooded holes.
- Hole drilling by hammer drill or compressed air drill mode.
- The installation of post-installed rebar shall be done only by suitable trained installer and under supervision on site; the conditions under which an installer may be considered as suitable trained and the conditions for supervision on site are up to the Member States in which the installation is done.
- Check the position of the existing rebars (if the position of existing rebars is not known, it shall be determined using a rebar detector suitable for this purpose as well as on the basis of the construction documentation and then marked on the building component for the overlap joint).

Injection system TCM385/585/1000/1400RE for rebar connection

Intended use
Specifications

Annex B 1

Figure B1: General design rules of construction for post-installed in rebars

- Only tension forces in the axis of the rebar may be transmitted
- The transfer of shear forces between new concrete and existing structure shall be designed additionally according to EN 1992-1-1:2004+AC:2010.
- The joints for concreting must be roughened to at least such an extent that aggregate protrude.

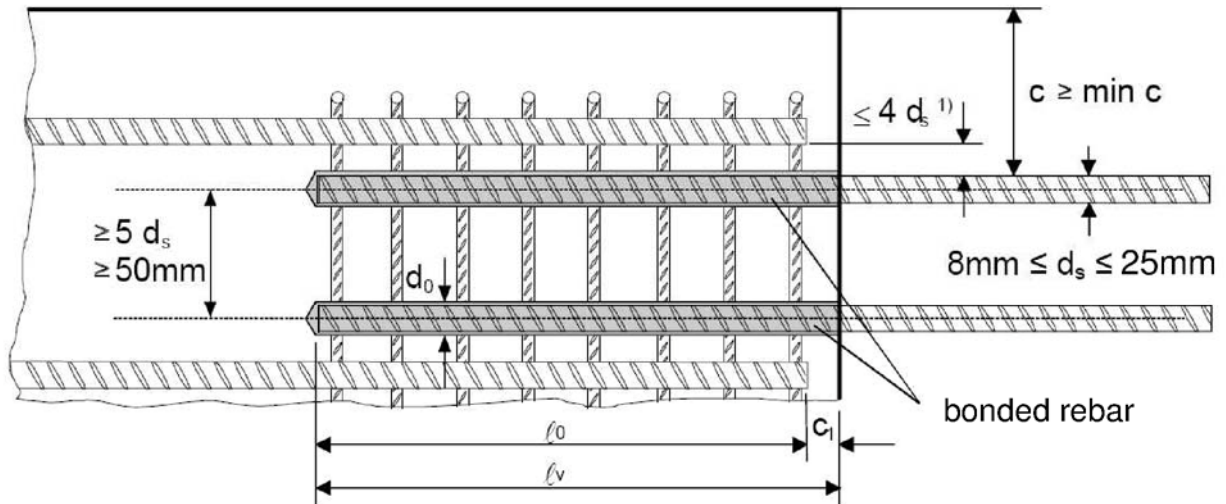

- 1) If the clear distance between lapped bars exceeds $4d_s$, then the lap length shall be increased by the difference between the clear bar distance and $4d_s$.

The following applies to Figure B1:

c	concrete cover of post-installed rebar
c_1	concrete cover at end-face of existing rebar
min c	minimum concrete cover according to Table B1 and to EN 1992-1-1:2004+AC:2010, Section 4.4.1.2
d_s	diameter of post-installed rebar
l_0	lap length, according to EN 1992-1-1:2004+AC:2010, Section 8.7.3
l_v	effective embedment depth, $\geq l_0 + c_1$
d_0	nominal drill bit diameter, see Annex B 6

Injection system TCM385/585/1000/1400RE for rebar connection

Intended use

General construction rules for post-installed rebars

Annex B 2

Table B1: Minimum concrete cover min c of bonded-in rebar depending of drilling method

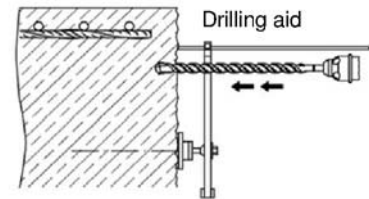

Drilling method	Rebar diameter	Without drilling aid	With drilling aid
Hammer drilling	< 25 mm	$30 \text{ mm} + 0,06 \cdot l_v \geq 2 d_s$	$30 \text{ mm} + 0,02 \cdot l_v \geq 2 d_s$
	= 25 mm	$40 \text{ mm} + 0,06 \cdot l_v \geq 2 d_s$	$40 \text{ mm} + 0,02 \cdot l_v \geq 2 d_s$
Compressed air drilling	< 25 mm	$50 \text{ mm} + 0,08 \cdot l_v$	$50 \text{ mm} + 0,02 \cdot l_v$
	= 25 mm	$60 \text{ mm} + 0,08 \cdot l_v$	$60 \text{ mm} + 0,02 \cdot l_v$

¹⁾ see Annexes B2, Figures B1
Comments: The minimum concrete cover acc. EN 1992-1-1:2004+AC:2010 must be observed

Table B2: Maximum installation length l_{\max}

Rebar $\varnothing d_s$	l_{\max} [mm]
8 mm	1000
10 mm	1000
12 mm	1200
14 mm	1400
16 mm	1600
20 mm	2000
22 mm	2000
24 mm	2000
25 mm	2000

Table B3: Base material temperature, gelling time and curing time

Concrete temperature	Gelling- / working time ¹⁾	Minimum curing time in dry concrete ²⁾
	t_{gel}	$t_{\text{cure,dry}}$
+5°C to +9°C	120 min	50 h
+10°C to +19°C	90 min	30 h
+20°C to +29°C	30 min	10 h
+30°C to +39°C	20 min	6 h
+40 °C	12 min	4 h

¹⁾ t_{gel} : maximum time from starting of mortar injection to completing of rebar setting.





²⁾ In wet concrete the curing time $t_{\text{cure,dry}}$ has to be doubled up

Injection system TCM385/585/1000/1400RE for rebar connection

Intended use
Minimum concrete cover
Maximum embedment depth / working time and curing times

Annex B 3

Table B4: Dispensing tools

Cartridge type/size	Hand tool	Pneumatic tool
Side-by-side cartridges 385, 585 ml	 e.g. SA 296C585	 e.g. Type TS 444 KX
Side-by-side cartridge 1000 ml	-	 e.g. Type TS 4104
Side-by-side cartridge 1400 ml	-	 e.g. Type TS 471

All cartridges could also be extruded by a battery tool.

Injection system TCM385/585/1000/1400RE for rebar connection

Intended Use

Dispensing tools

Annex B 4

A) Bore hole drilling

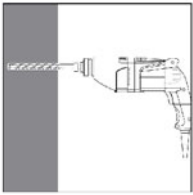

1. Drill a hole into the base material to the size and embedment depth required by the selected reinforcing bar with carbide hammer drill (HD) or a compressed air drill (CD).

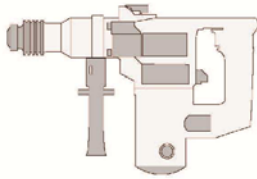

Hammer drill (HD)

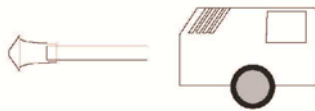

Compressed air drill (CD)

Rebar - Ø	Drill - Ø
d_s	[mm]
8 mm	12
10 mm	14
12 mm	16
14 mm	18
16 mm	20
20 mm	25
22 mm	28
24 mm	32
25 mm	32

B) Bore hole cleaning

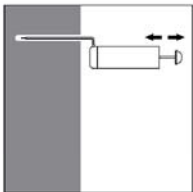

- 2a. Starting from the bottom or back of the bore hole, blow the hole clean with compressed air (min. 6 bar) or a hand pump a minimum of two times. If the bore hole ground is not reached an extension shall be used.

For bore holes deeper than 240 mm, compressed air (min. 6 bar) **must** be used.

or

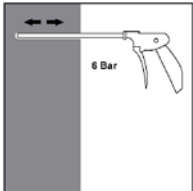

- 2b. Check brush diameter (Table B5) and attach the brush to a drilling machine or a battery screwdriver. Brush the hole with an appropriate sized wire brush $> d_{b,min}$ (Table B5) a minimum of two times. If the bore hole ground is not reached with the brush, a brush extension shall be used.

- 2c. Finally blow the hole clean again with compressed air (min. 6 bar) or a hand pump a minimum of two times. If the bore hole ground is not reached an extension shall be used.

For bore holes deeper than 240 mm, compressed air (min. 6 bar) **must** be used.

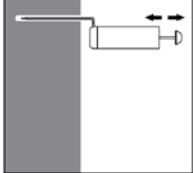

or

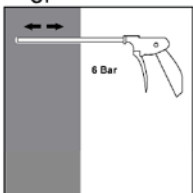

Injection system TCM385/585/1000/1400RE for rebar connection

Intended Use

Installation instruction: Bore hole drilling and
Bore hole cleaning

Annex B 5

Table B5: Cleaning tools

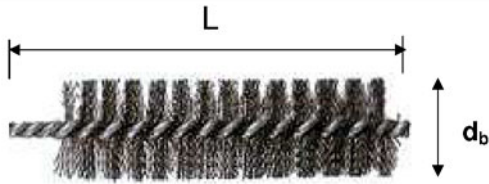

Brush elongation



SDS Plus Adapter



Hand pump (volume 750 ml)

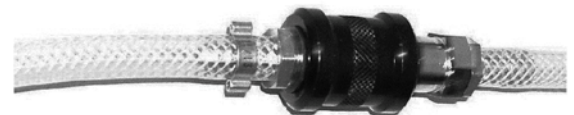

**Rec. compressed air tool
hand slide valve (min 6 bar)**

d_s Rebar - Ø	d_0 Drill bit - Ø	d_b Brush - Ø	$d_{b,min}$ min. Brush - Ø
(mm)	(mm)	(mm)	(mm)
8	12	14	12,5
10	14	16	14,5
12	16	18	16,5
14	18	20	18,5
16	20	22	20,5
20	25	27	25,5
22	28	30	28,5
24	32	34	32,5
25	32	34	32,5

C) Preparation of bar and cartridge

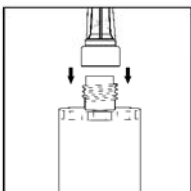

3. Attach the supplied static-mixing nozzle to the cartridge and load the cartridge into the correct dispensing tool.
For every working interruption longer than the recommended working time (Table B3) as well as for every new cartridges, a new static-mixer shall be used.

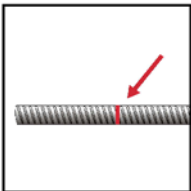

4. Prior to inserting the reinforcing bar into the filled bore hole, the position of the embedment depth shall be marked (e.g. with tape) on the reinforcing bar and insert bar in empty hole to verify hole and depth l_v .
The anchor should be free of dirt, grease, oil or other foreign material.

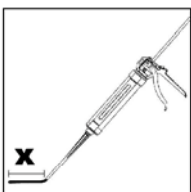

5. Prior to dispensing into the anchor hole, squeeze out separately the mortar until it shows a consistent grey colour, but a minimum of three full strokes, and discard non-uniformly mixed adhesive components.

Injection system TCM385/585/1000/1400RE for rebar connection

Intended Use
Installation instruction: Cleaning tools and
Preparation of bar and cartridge

Annex B 6

D) Filling the bore hole

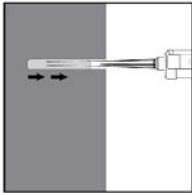

6. Starting from the bottom or back of the cleaned anchor hole fill the hole up to approximately two-thirds with adhesive. Slowly withdraw the static mixing nozzle as the hole fills to avoid creating air pockets. For embedment larger than 190 mm an extension nozzle shall be used.

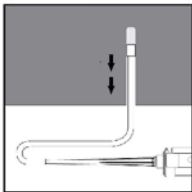

For overhead and horizontal installation and bore holes deeper than 240 mm a piston plug and the appropriate mixer extension must be used.

Observe the gel-/ working times given in Table B3.

Table B6: Piston plugs, max anchorage depth and mixer extension

Bar size	Drill bit - Ø		Piston plug	Cartridge: side-by-side (385, 585, 1000, 1400 ml)				Cartridge: side-by-side (1000, 1400 ml)		
	HD	PD		Hand or battery tool		Pneumatic tool		Pneumatic tool		
				l_{max}	Mixer extension	l_{max}	Mixer extension	l_{max}	Mixer extension	
(mm)	(mm)		No.	(cm)		(cm)		(cm)		
8	12	-	-	70	VL 10/0,75	80	VL 10/0,75	80	VL 10/0,75	
10	14	-	#14			100		100		
12	16		#16			120		120		
14	18		#18			140		140		
16	20		#20			160		160		
20	25	26	#25	50	VL 10/0,75	70	VL 10/0,75	200	VL 16/1,8	
22	28		#28			50				50
24	32		#32			50				50
25	32		#32			50				50

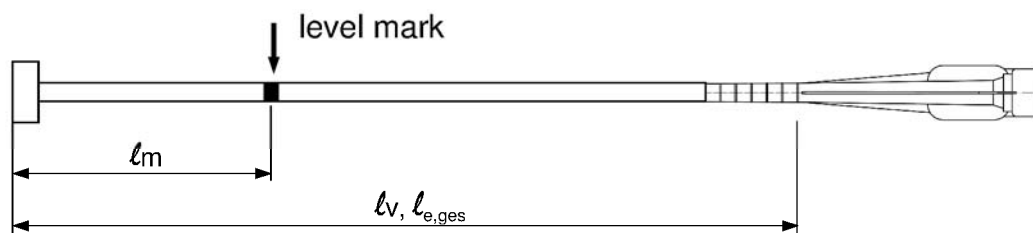

Injection tool must be marked by mortar level mark l_m and anchorage depth l_v resp. $l_{e,ges}$ with tape or marker.

Quick estimation: $l_m = 1/3 \cdot l_v$

Continue injection until the mortar level mark l_m becomes visible.

Optimum mortar volume: $l_m = l_v$ resp. $l_{e,ges} \cdot \left(1,2 \cdot \frac{d_s^2}{d_0^2} - 0,2 \right)$ [mm]

Injection system TCM385/585/1000/1400RE for rebar connection

Intended Use
Installation instruction: Filling the bore hole

Annex B 7

E) Inserting the rebar

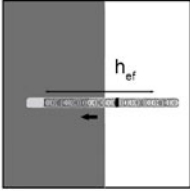

7. Push the reinforcing bar into the anchor hole while turning slightly to ensure positive distribution of the adhesive until the embedment depth is reached.

The bar should be free of dirt, grease, oil or other foreign material.

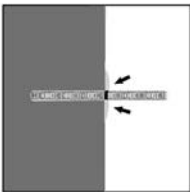

8. Be sure that the bar is inserted in the bore hole until the embedment mark is at the concrete surface and that excess mortar is visible at the top of the hole. If these requirements are not maintained, the application has to be renewed. For overhead installation fix embedded part (e.g. wedges).



9. Observe gelling time t_{gel} . Attend that the gelling time can vary according to the base material temperature (see Table B3). It is not allowed to move the bar after gelling time t_{gel} has elapsed.
Allow the adhesive to cure to the specified time prior to applying any load. Do not move or load the bar until it is fully cured (attend Table B3). After full curing time t_{cure} has elapsed, the add-on part can be installed.

Minimum anchorage length and minimum lap length

The minimum anchorage length $\ell_{b,min}$ and the minimum lap length $\ell_{0,min}$ according to EN 1992-1-1:2004+AC:2010 ($\ell_{b,min}$ acc. to Eq. 8.6 and Eq. 8.7 and $\ell_{0,min}$ acc. to Eq. 8.11) shall be multiply by a factor according to Table C1.

Concrete class	Drilling method	Factor
C12/15 to C50/60	Hammer drilling and compressed air drilling	1,0

Table C2: Design values of the ultimate bond resistance f_{bd} in N/mm² for all drilling methods for good conditions

according to EN 1992-1-1:2004+AC:2010 for good bond conditions
(for all other bond conditions multiply the values by 0.7)

Rebar - \emptyset	Concrete class								
	C12/15	C16/20	C20/25	C25/30	C30/37	C35/45	C40/50	C45/55	C50/60
d_s									
8 to 25 mm	1,6	2,0	2,3	2,7	3,0	3,4	3,7	4,0	4,3

Injection system TCM385/585/1000/1400RE for rebar connection

Performances

Minimum anchorage length and minimum lap length
Design values of ultimate bond resistance f_{bd}

Annex C 1